

Unico

CENNIK
MARZEC 2026



GWARANCJA
JAKOŚCI

SPIS TREŚCI

KLIKNIJ, ABY PRZEJŚĆ NA WYBRANĄ STRONĘ

KONFIGURACJA	3
DRAGON WKŁADY BEZRUSZTOWE POWIETRZNE	4
DRAGON – Wkłady proste	4
DRAGON – Wkłady narożne	5
DRAGON – Wkłady portalowe	6
DRAGON – Wkłady vis-a-vis	7
NEMO WKŁADY BEZRUSZTOWE WODNE	8
NEMO – Wkłady proste	8
NEMO – Wkłady narożne	9
NEMO – Wkłady vis-a-vis	9
DRAGON AKU WKŁADY AKUMULACYJNE	10
DRAGON AKU – Wkłady proste	10
DRAGON AKU – Wkłady narożne	10
MODUŁY AKUMULACYJNE	11
BLENDY WYKOŃCZENIOWE	12
Blendy – licujące bez zagłębienia	12
Blendy – do zagłębienia	12
Blendy LIFT – do wkładów z systemem PowerLIFT	13
MATERIAŁY AKUMULACYJNE	14
AKU Box – Wymiennik stalowo-zasypowy	14
EASY 700 – Wymiennik stalowo-szamotowy	14
Moduły termoakumulacyjne	15
Zawiesia termoakumulacyjne	15
STEROWNIKI	16
UNICO FUSION ZABUDOWY BETONOWE	18

KONFIGURACJA

BLACK

- grafitowa ceramika Cerabox
- szyba z czarnym nadrukiem maskującym ramę
- czarna klamka Design



WHITE

- jasna ceramika Refrabox
- szyba z czarnym nadrukiem maskującym ramę
- czarno-srebrna klamka Design

SZYBA PROSTA SZYBY VIS-A-VIS

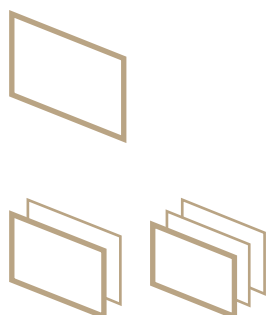

SZYBA NAROŻNA

gięta



łączona



SZYBA TYPU "C"

łączona

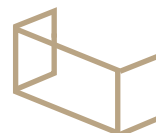

SZYBA PÓŁOKRĄGŁA



KLAMKA DESIGN



czarno-
srebrna
K5



czarna
K7

KLAMKA CLASSIC



czarna
K1







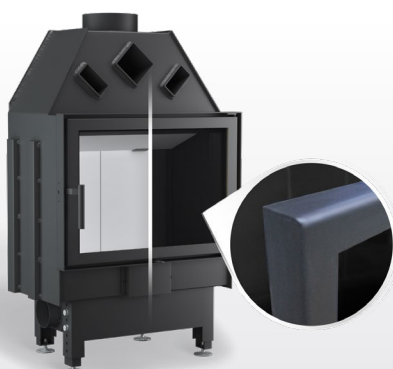





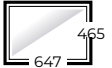
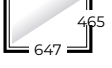
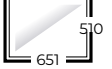

srebrna
K2

KLAMKA LIFT

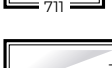
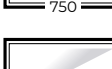
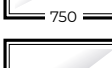
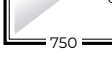
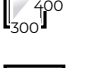

Możliwość zmiany szyby na klasyczną (bez nadruku) w stalowej ramie

DRAGON – WKŁADY PROSTE

MODEL	SYSTEM OTWIERANIA	CENA WKŁADU zł netto			CENA BLENDY zł netto						FASADA mm
		SZYBA			BLENDY LICUJĄCE tylko drzwi standard		BLENDY ZAGŁĘBIAJĄCE RZ - drzwi standard RL - drzwi LIFT				
		x1 	x2 	x3 	szer. 15 mm bez wywinięcia	szer. 30 mm 9 mm wywinięcie	szer. 15 mm bez wywinięcia	szer. 30 mm 9 mm wywinięcie	szer. 15 mm bez wywinięcia kąt 45 °	szer. 5 mm bez wywinięcia	
KOD KONFIGURACJI	S2	S3	S11	R15	R30	RZ15 RL15	RZ30 RL30	RZ45	RL05		
DRAGON 2 SLIM 6 kW	Standard	8140	8780	9530	360	410	450	530	560	-	
	LIFT	11080	11720	12470	-	-	430	500	-	950	
DRAGON 2 12 kW	Standard	8190	8830	9580	360	410	450	530	560	-	
	LIFT	11130	11770	12520	-	-	430	500	-	950	
DRAGON 2 XL 12 kW	Standard	8670	9370	10120	370	420	490	550	600	-	
	LIFT	11610	12310	13060	-	-	440	510	-	960	
DRAGON 4 SLIM 14 kW	Standard	8730	9470	10280	390	430	500	560	630	-	
	LIFT	11670	12420	13220	-	-	450	530	-	990	
DRAGON 4 XL SLIM 14 kW	Standard	9100	9960	10920	410	450	540	590	680	-	
	LIFT	12040	12900	13860	-	-	560	550	-	1010	
DRAGON 4 16 kW	Standard	9100	9850	10650	390	430	500	560	630	-	
	LIFT	12040	12790	13590	-	-	450	530	-	990	
DRAGON 4 XL 16 kW	Standard	9740	10600	11560	390	450	540	590	680	-	
	LIFT	12680	13540	14500	-	-	560	550	-	1010	
DRAGON 6 12 kW	Standard	8890	9630	10440	360	410	470	540	580	-	
	LIFT	11830	12580	13380	-	-	420	500	-	950	
DRAGON 6 XL 12 kW	Standard	9420	10280	11240	390	440	500	560	630	-	
	LIFT	12360	13220	14180	-	-	450	530	-	990	
DRAGON 6 XXL 12 kW	Standard	10010	11080	12360	420	500	550	640	690	-	
	LIFT	12950	14020	15310	-	-	510	580	-	1100	
DRAGON 8 MINI 6 kW	Standard	5460	-	-	300	410	-	-	490	-	
	LIFT	-	-	-	-	-	-	-	-	-	
DRAGON 8 SLIM 9 kW	Standard	7440	8030	8730	300	350	390	440	490	-	
	LIFT	10380	10970	11670	-	-	360	410	-	780	
DRAGON 8 11 kW	Standard	7660	8240	8940	300	350	390	440	490	-	
	LIFT	10600	11190	11880	-	-	360	410	-	780	
DRAGON 8R 11 kW	Standard	7710	-	-	-	390	-	-	-	-	
	LIFT	-	-	-	-	-	-	-	-	-	
DRAGON 8 XXL 13 kW	Standard	8190	8990	9900	360	410	470	540	580	-	
	LIFT	11130	11940	12840	-	-	420	500	-	950	
DRAGON 9 14 kW	Standard	11030	11990	13170	420	500	550	640	690	-	
	LIFT	13970	14930	16110	-	-	510	580	-	1100	
DRAGON 9 XL 14 kW	Standard	12200	13330	14660	490	570	640	730	800	-	
	LIFT	15150	16270	17610	-	-	580	670	-	1270	

DRAGON – WKŁADY NAROŻNE

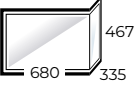
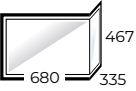
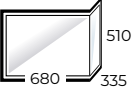
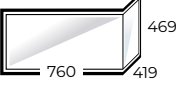
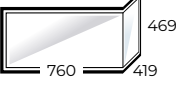
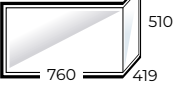
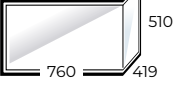
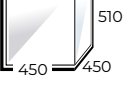
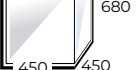
MODEL	SYSTEM OTWIERANIA	CENA WKŁADU zł netto				CENA BLENDY zł netto						FASADA mm
		SZYBA				BLENDY LICUJĄCE tylko drzwi standard		BLENDY ZAGŁĘBIAJĄCE RZ - drzwi standard RL - drzwi LIFT				
		szyba dzielona	szyba gięta	szyba dzielona x2	szyba gięta x2	szer. 15 mm bez wywiniecia	szer. 30 mm 9 mm wywiniecie	szer. 15 mm bez wywiniecia	szer. 30 mm 9 mm wywiniecie	szer. 15 mm bez wywiniecia kąt 45°	szer. 5 mm bez wywiniecia	
KOD KONFIGURACJI			S3	S11	R15	R30	RZ15 RL15	RZ30 RL30	RZ45	RL05		
DRAGON 2B SLIM 6 kW	Standard	9310	10380	11450	12520	600	690	790	900	990	-	
	LIFT	12950	14020	15090	16160	-	-	730	850	-	1600	
DRAGON 2B 12 kW	Standard	9420	10490	11560	12630	600	690	790	900	990	-	
	LIFT	13060	14130	15200	16270	-	-	730	850	-	1600	
DRAGON 2B XL 12 kW	Standard	9630	-	-	-	650	740	850	970	1050	-	
	LIFT	13270	-	-	-	-	-	780	890	-	1680	
DRAGON 4B SLIM 13 kW	Standard	10920	12200	13700	14980	680	780	870	1000	1100	-	
	LIFT	14660	15950	17450	18730	-	-	820	950	-	1780	
DRAGON 4B 16 kW	Standard	11080	12360	13860	15150	680	780	870	1000	1100	-	
	LIFT	14820	16110	17610	18890	-	-	820	950	-	1780	
DRAGON 4B XL SLIM 13 kW	Standard	11240	-	-	-	690	790	900	1040	1130	-	
	LIFT	14980	-	-	-	-	-	830	960	-	1810	
DRAGON 4B XL 16 kW	Standard	11400	-	-	-	690	790	900	1040	1130	-	
	LIFT	15150	-	-	-	-	-	830	960	-	1810	
DRAGON 8B 11 kW	Standard	8240	-	-	-	590	680	780	890	970	-	
	LIFT	11770	-	-	-	-	-	-	820	-	1550	
DRAGON 8B XXL 13 kW	Standard	9420	-	-	-	670	760	860	990	1070	-	
	LIFT	13060	-	-	-	-	-	790	900	-	1720	

DRAGON 2C – WKŁAD TRÓJSTRONNY

To trójstronna wizja ognia w najnowocześniejszym wydaniu.



Model dostępny tylko z systemem podnoszenia szyby **POWERLIFT**.

DRAGON 2C 12 kW	Standard	-	-	-	-	-	-	-	-	-	-	
	LIFT	15840	-	-	-	-	-	900	-	-	-	

DRAGON – WKŁADY PORTALOWE

MODEL	SYSTEM OTWIERANIA	CENA WKŁADU zł netto			CENA BLENDY zł netto						FASADA mm
		SZYBA			BLENDY LICUJĄCE tylko drzwi standard		BLENDY ZAGŁĘBIAJĄCE RZ - drzwi standard RL - drzwi LIFT				
		x1 	x2 	x3 	szer. 15 mm bez wywinięcia	szer. 30 mm 9 mm wywinięcie	szer. 15 mm bez wywinięcia	szer. 30 mm 9 mm wywinięcie	szer. 15 mm bez wywinięcia kąt 45°	szer. 5 mm bez wywinięcia	
KOD KONFIGURACJI	S2	S3	S11	R15	R30	RZ15 RL15	RZ30 RL30	RZ45	RL05		
DRAGON 2 PORTAL 12 kW	Standard	8460	9100	9850	360	410	450	530	560	-	
	LIFT	11400	12040	12790	-	-	420	500	-	950	
DRAGON 2 XL PORTAL 12 kW	Standard	8890	9580	10330	370	420	490	550	600	-	
	LIFT	11830	12520	13270	-	-	440	510	-	960	
DRAGON 4 SLIM PORTAL 14 kW	Standard	8990	9740	10540	390	440	500	560	630	-	
	LIFT	11940	12680	13490	-	-	450	530	-	990	
DRAGON 4 SLIM XL PORTAL 4-14 kW	Standard	9370	10220	11190	390	440	500	560	630	-	
	LIFT	12310	13170	14130	-	-	450	530	-	990	
DRAGON 4 PORTAL 16 kW	Standard	9370	10120	10920	390	440	500	560	630	-	
	LIFT	12310	13060	13860	-	-	450	530	-	990	
DRAGON 4 XL PORTAL 16 kW	Standard	10060	10920	11880	390	440	500	560	630	-	
	LIFT	13010	13860	14820	-	-	450	530	-	990	
DRAGON 6 XL PORTAL 12 kW	Standard	9630	10490	11450	390	440	500	560	630	-	
	LIFT	12580	13430	14400	-	-	450	530	-	990	
DRAGON 6 XXL PORTAL 12 kW	Standard	10280	11350	12630	420	500	550	640	690	-	
	LIFT	13220	14290	15570	-	-	510	580	-	1100	

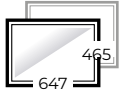
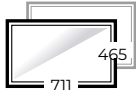
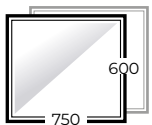
DRAGON – WKŁADY VIS-A-VIS

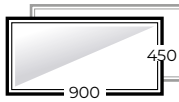
MODEL	SYSTEM OTWIERANIA	CENA WKŁADU zł netto			CENA BLENDY zł netto						FASADA mm
		SZYBA			BLENDY LICUJĄCE tylko drzwi standard		BLENDY ZAGŁĘBIAJĄCE RZ - drzwi standard RL - drzwi LIFT				
		x1	x2	x3	szer. 15 mm bez wywiniecia	szer. 30 mm 9 mm wywiniecie	szer. 15 mm bez wywiniecia	szer. 30 mm 9 mm wywiniecie	szer. 15 mm bez wywiniecia kąt 45°	szer. 5 mm bez wywiniecia	
KOD KONFIGURACJI	S2	S3	S11	R15	R30	RZ15 RL15	RZ30 RL30	RZ45	RL05		
DRAGON 2 DUO 12 kW	Standard	9310	10600	12100	360	410	450	530	560	-	
	LIFT*	12260	13540	15040	-	-	430	500	-	950	
DRAGON 4 DUO 16 kW	Standard	10330	11830	13430	390	430	500	560	630	-	
	LIFT*	13270	14770	16380	-	-	450	530	-	990	
DRAGON 6 XXL DUO 12 kW	Standard	11290	13430	16000	420	500	550	640	690	-	
	LIFT*	14240	16380	18940	-	-	510	580	-	1100	
DRAGON 8 DUO 11 kW	Standard	8190	9370	10760	300	350	390	440	490	-	
	LIFT*	11130	12310	13700	-	-	360	410	-	780	
DRAGON 8 XXL DUO 13 kW	Standard	9580	11190	13010	360	410	470	540	580	-	
	LIFT*	12520	14130	15950	-	-	420	500	-	950	
DRAGON 9 DUO 13 kW	Standard	12040	13970	16320	420	500	550	640	690	-	
	LIFT*	14980	16910	19260	-	-	510	580	-	1100	

* Cena dotyczy systemu LIFT z jednej strony, w przypadku systemu LIFT z dwóch stron - wycena indywidualna.

** Cena szyb podwójnych i potrójnych dotyczy obu stron kominka.

*** Cena dotyczy blendy z jednej strony.

**** W przypadku zastosowania niesymetrycznego przeszklenia podwójnego lub potrójnego, połączenia drzwi serwisowych z podwójnym lub potrójnym przeszkleniem – wycena indywidualna.







NEMO

WKŁADY BEZRUSZTOWE WODNE



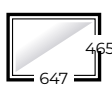
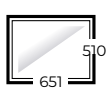
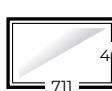
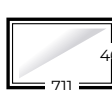
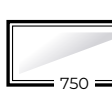



Zabezpieczenie termiczne chłodnicy: **420 zł netto**

Wkłady Nemo wyposażone są w węzownicę schładzającą (w cenie).

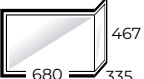

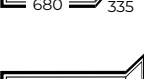
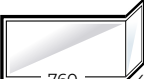
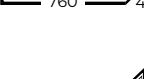

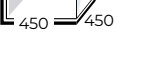

NEMO – WKŁADY PROSTE

MODEL	SYSTEM OTWIERANIA	CENA WKŁADU zł netto			CENA BLENDY zł netto						FASADA mm
		SZYBA			BLENDY LICUJĄCE tylko drzwi standard		BLENDY ZAGŁĘBIAJĄCE RZ - drzwi standard RL - drzwi LIFT				
		x1 	x2 	x3 	szer. 15 mm bez wywinięcia	szer. 30 mm 9 mm wywinięcie	szer. 15 mm bez wywinięcia	szer. 30 mm 9 mm wywinięcie	szer. 15 mm bez wywinięcia kąt 45°	szer. 5 mm bez wywinięcia	
KOD KONFIGURACJI	S2	S3	S11	R15	R30	RZ15 RL15	RZ30 RL30	RZ45	RL05		
NEMO 2 16 kW	Standard	10970	11610	12360	360	410	450	530	560	-	
	LIFT	13910	14560	15310	-	-	430	500	-	950	
NEMO 2 XL 16 kW	Standard	11450	12150	12900	370	420	490	550	600	-	
	LIFT	14400	15090	15840	-	-	440	510	-	960	
NEMO 4 SLIM 20 kW	Standard	11940	12680	13490	390	430	500	560	630	-	
	LIFT	14880	15630	16430	-	-	450	530	-	990	
NEMO 4 21 kW	Standard	12420	13170	13970	390	430	500	560	630	-	
	LIFT	15360	16110	16910	-	-	450	530	-	990	
NEMO 6 18 kW	Standard	11450	12200	13010	360	410	470	540	580	-	
	LIFT	14400	15150	15950	-	-	420	500	-	950	
NEMO 6 XL 18 kW	Standard	11990	12840	13810	390	440	500	560	630	-	
	LIFT	14930	15790	16750	-	-	450	530	-	990	
NEMO 8 12 kW	Standard	9690	10280	10970	300	350	390	440	490	-	
	LIFT	12630	13220	13910	-	-	360	410	-	780	
NEMO 9 20 kW	Standard	13490	14450	15630	420	500	550	640	690	-	
	LIFT	16430	17390	18570	-	-	510	580	-	1100	

NEMO – WKŁADY NAROŻNE

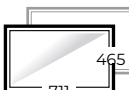
MODEL	SYSTEM OTWIERANIA	CENA WKŁADU zł netto				CENA BLENDY zł netto						FASADA mm
		SZYBA				BLENDY LICUJĄCE tylko drzwi standard		BLENDY ZAGŁĘBIAJĄCE RZ - drzwi standard RL - drzwi LIFT				
		szyba dzielona	szyba gięta	szyba dzielona x2	szyba gięta x2	szer. 15 mm bez wywinięcia	szer. 30 mm 9 mm wywinięcie	szer. 15 mm bez wywinięcia	szer. 30 mm 9 mm wywinięcie	szer. 15 mm bez wywinięcia kąt 45°	szer. 5 mm bez wywinięcia	
KOD KONFIGURACJI	S2	S6	S3	S11	R15	R30	RZ15 RL15	RZ30 RL30	RZ45	RL05		
NEMO 2B 15 kW	Standard	11770	12740	13910	14880	600	690	790	900	990	-	
	LIFT	15410	16380	17550	18520	-	-	730	850	-	1600	
NEMO 2B XL 15 kW	Standard	11990	-	-	-	650	740	850	970	1050	-	
	LIFT	15630	-	-	-	-	-	780	890	-	1680	
NEMO 4B SLIM 20 kW	Standard	13590	14660	16380	17450	680	780	870	1000	1100	-	
	LIFT	17230	18300	20010	21080	-	-	820	950	-	1780	
NEMO 4B 22 kW	Standard	13910	14980	16700	17770	680	780	870	1000	1100	-	
	LIFT	17550	18620	20330	21400	-	-	820	950	-	1780	
NEMO 8B 12 kW	Standard	10600	-	-	-	590	680	780	890	970	-	
	LIFT	14240	-	-	-	-	-	710	820	-	1550	

NEMO – WKŁADY VIS-A-VIS

MODEL	SYSTEM OTWIERANIA	CENA WKŁADU zł netto			CENA BLENDY zł netto						FASADA mm
		SZYBA			BLENDY LICUJĄCE tylko drzwi standard		BLENDY ZAGŁĘBIAJĄCE RZ - drzwi standard RL - drzwi LIFT				
		x1	x2	x3	szer. 15 mm bez wywinięcia	szer. 30 mm 9 mm wywinięcie	szer. 15 mm bez wywinięcia	szer. 30 mm 9 mm wywinięcie	szer. 15 mm bez wywinięcia kąt 45°	szer. 5 mm bez wywinięcia	
KOD KONFIGURACJI	S2	S3	S11	R15	R30	RZ15 RL15	RZ30 RL30	RZ45	RL05		
NEMO 2 DUO 16 kW	Standard	11610	12900	14400	360	410	450	530	560	-	
	LIFT*	14560	16750	17450	-	-	430	500	-	950	
NEMO 4 DUO 21 kW	Standard	12950	14450	16050	390	430	500	560	630	-	
	LIFT*	15890	18250	18940	-	-	450	530	-	990	
NEMO 9 DUO 20 kW	Standard	14770	16700	19050	420	500	550	640	690	-	
	LIFT*	17710	20920	21990	-	-	510	580	-	1100	

* Cena dotyczy systemu LIFT z jednej strony, w przypadku systemu LIFT z dwóch stron - wycena indywidualna.

** Cena szyb podwójnych i potrójnych dotyczy obu stron kominka.

*** Cena dotyczy blendy z jednej strony.

**** W przypadku zastosowania niesymetrycznego przeszklenia podwójnego lub potrójnego, połączenia drzwi serwisowych z podwójnym lub potrójnym przeszkleniem – wycena indywidualna.















DRAGON AKU WKŁADY AKUMULACYJNE

Wszystkie wkłady Dragon Aku dostępne tylko w wersji **Standard** (szyba otwierana do boku).

Wkłady proste dostępne również w wersji AKU+. Dopłata do wersji AKU+ 860 zł netto.







Ceny wkładów bez modułów akumulacyjnych.

DRAGON AKU – WKŁADY PROSTE

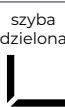
MODEL DRAGON AKU	CENA WKŁADU zł netto			CENA BLENDY zł netto					FASADA mm
	SZYBA			BLENDY LICUJĄCE		BLENDY ZAGŁĘBIAJĄCE			
	x1 	x2 	x3 	szer. 15 mm bez wywinięcia	szer. 30 mm 9 mm wywinięcie	szer. 15 mm bez wywinięcia	szer. 30 mm 9 mm wywinięcie	szer. 15 mm bez wywinięcia kąt 45 °	
KOD KONFIGURACJI	S2	S3	S11	R15	R30	RZ15	RZ30	RZ45	
2 12 kW	8190	8830	9580	360	410	450	530	560	
2 XL 12 kW	8670	9370	10120	370	420	490	550	600	
4 SLIM 14 kW	8730	9470	10280	390	430	500	560	630	
4 16 kW	9100	9850	10650	390	430	500	560	630	
4 DUO 16 kW	10330	11830	13430	390	430	500	560	630	
6 12 kW	8890	9630	10440	360	410	470	540	580	
6 XL 12 kW	9420	10280	11240	390	440	500	560	630	
9 14 kW	11030	11990	13170	420	500	550	640	690	
9 DUO 13 kW	12040	13970	16320	420	500	550	640	690	
8* 11 kW	7660	8240	8940	300	350	390	440	490	
8 DUO* 11 kW	8190	9370	10760	300	350	390	440	490	

* Modele Dragon 8 i Dragon 8 DUO dostępne jedynie w wersji AKU. Do wkładów dołączany jest stelaż na moduły akumulacyjne.

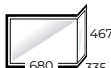
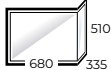
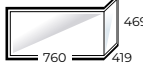
DRAGON AKU – WKŁADY NROŻNE

MODEL DRAGON AKU	CENA WKŁADU zł netto				CENA BLENDY zł netto					FASADA mm
	SZYBA				BLENDY LICUJĄCE		BLENDY ZAGŁĘBIAJĄCE			
	szyba dzielona 	szyba gięta 	szyba dzielona x2 	szyba gięta x2 	szer. 15 mm bez wywinięcia	szer. 30 mm 9 mm wywinięcie	szer. 15 mm bez wywinięcia	szer. 30 mm 9 mm wywinięcie	szer. 15 mm bez wywinięcia kąt 45 °	
KOD KONFIGURACJI	S2	S6	S3	S11	R15	R30	RZ15	RZ30	RZ45	
2B 12 kW	9420	10490	11560	12630	600	690	790	900	990	
2B XL 12 kW	9630	-	-	-	650	740	850	970	1050	
4B SLIM 13 kW	10920	12200	13700	14980	680	780	870	1000	1100	
4B 16 kW	11080	12360	13860	15150	680	780	870	1000	1100	

MODUŁY AKUMULACYJNE

WARIANT	CENA zł netto	Waga kg	Wymiary WxSxG cm
CMA N	2880	333	112x56x35
CMA S	3030	338	119x56x28



CMA N

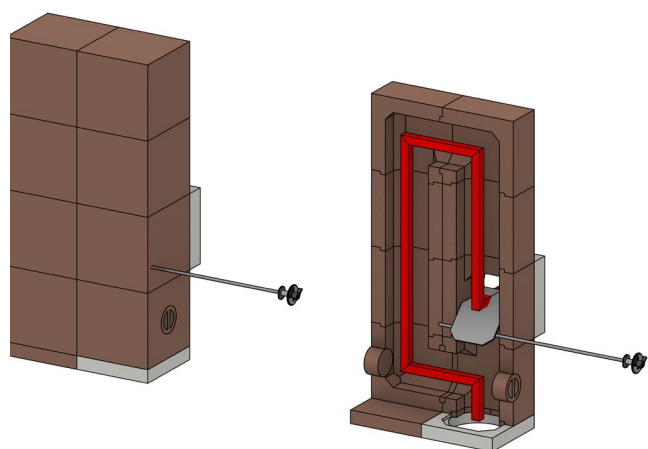

CMA S

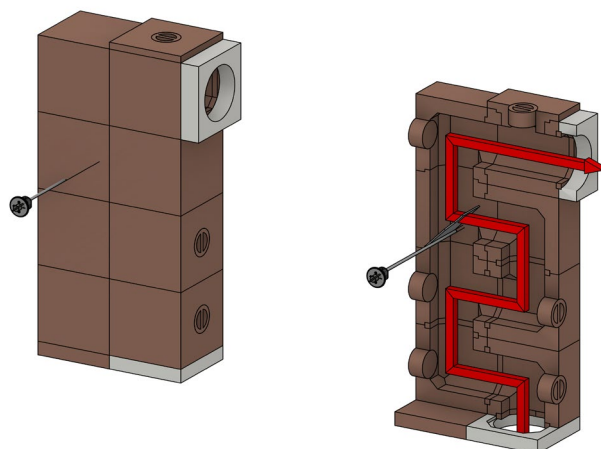

Moduły CMA N i CMA S mogą być zamontowane zarówno na wkładach prostych jak i narożnych.

DRAGON AKU



DRAGON AKU+



BLENDY WYKOŃCZENIOWE DLA WKŁADÓW DRAGON I NEMO

BLENDY – LICUJĄCE BEZ ZAGŁĘBIENIA

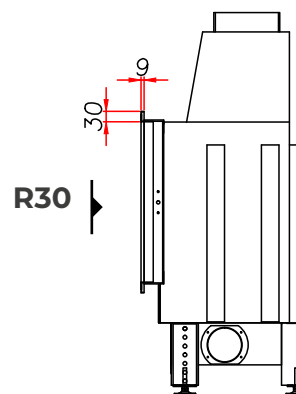
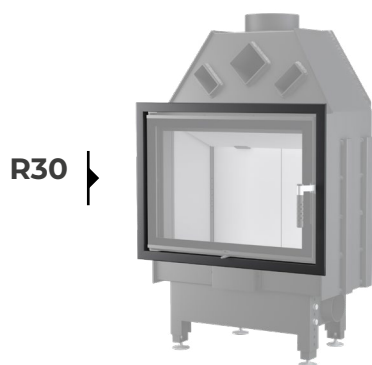
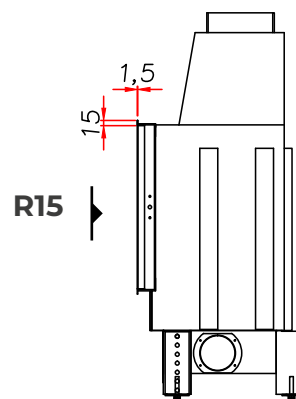
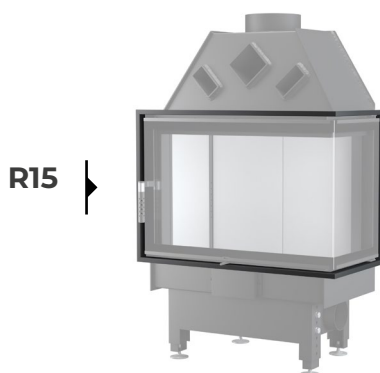
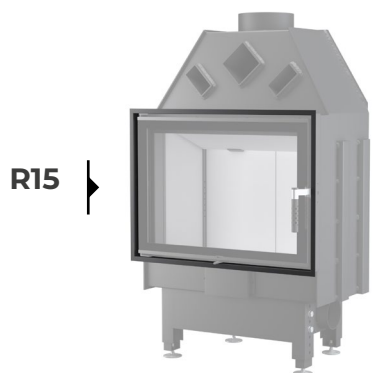

BLENDY – DO ZAGŁĘBIENIA

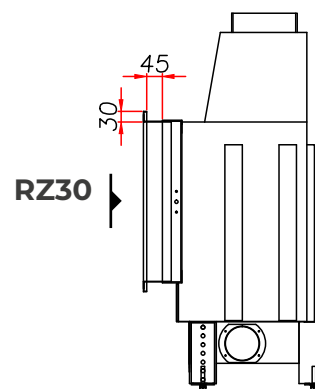
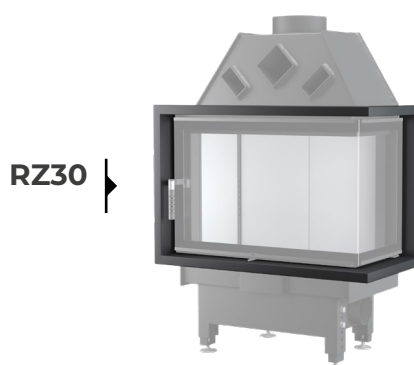
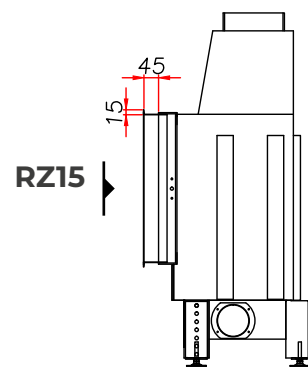
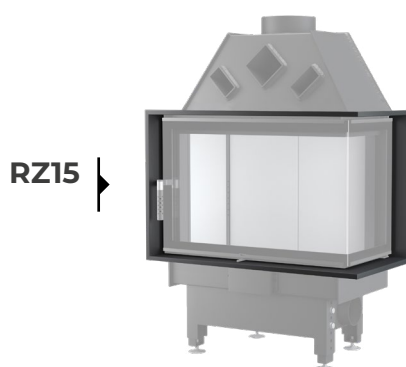
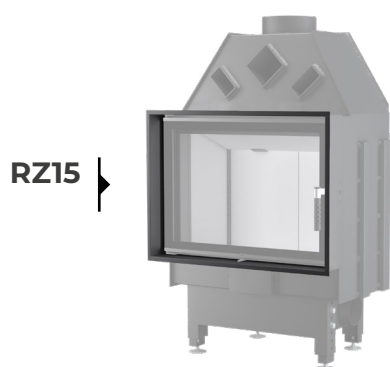

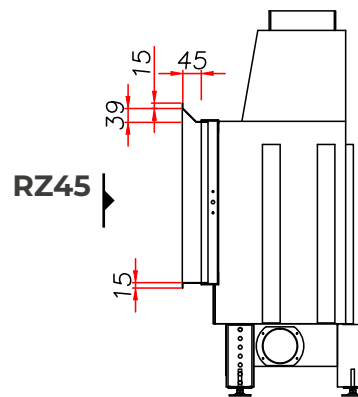
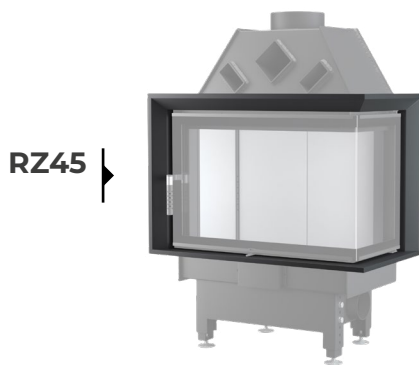
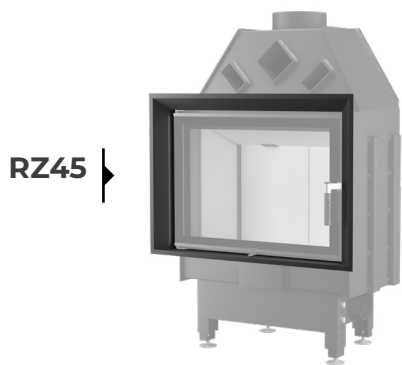

BLENDY LIFT – DO WKŁADÓW Z SYSTEMEM POWERLIFT

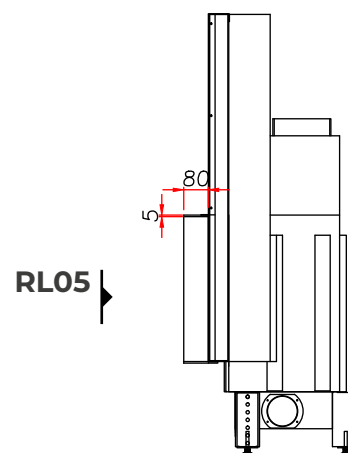
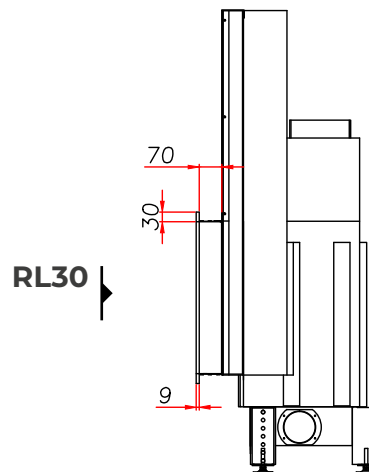
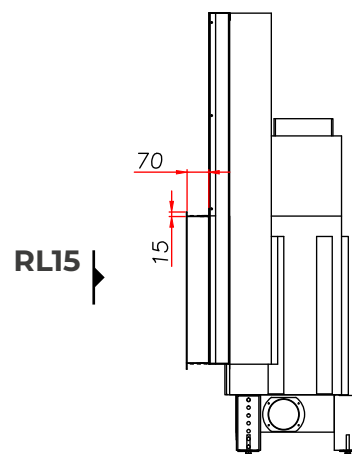

MATERIAŁY AKUMULACYJNE

AKU BOX – WYMIENNIK STALOWO-ZASYPOWY

Stalowo-zasypowy wymiennik akumulujący energię, obniżający temperaturę spalin i pozwalający zaoszczędzić miejsce przy kominku. Idealny do nowoczesnego, energooszczędnego budownictwa.

Model	Ciężar [kg]	Cena netto [zł]
Dragon 2 Dragon 2 XL Dragon 2B Dragon 2B XL	235	2980
Dragon 4 Slim Dragon 4B Slim	285	3500
Dragon 4 Dragon 4B	371	4540
Dragon 6 Dragon 6 XL	301	3760
Dragon 9	390	4760



EASY 700 – WYMIENNIK STALOWO-SZAMOTOWY

Stalowo-szamotowy wymiennik akumulujący energię, obniżający temperaturę spalin. Idealny do nowoczesnego, energooszczędnego budownictwa.

Moc grzewcza [kW]	5
Ciężar [kg]	80
Średnica komina [mm]	180
Cena netto [zł] cena zawiera regulowane nóżki	2210



MODUŁY TERMOAKUMULACYJNE

DRAGON SERIA 2* / 4 / 6 / 9

jeden poziom ze stojakiem

Ciężar [kg]	Wymiary sz/w/g [mm]	Cena netto [zł]
34,5	600 / 370 / 80	260

* nie dotyczy Dragon 2 Slim i Dragon 2B Slim



DRAGON SERIA 8

jeden poziom ze stojakiem

Ciężar [kg]	Wymiary sz/w/g [mm]	Cena netto [zł]
21	370 / 370 / 80	235



ZAWIESIA TERMOAKUMULACYJNE

KOMPLET Z UCHWYTAMI

Model	Ciężar [kg]	Cena netto [zł]
Dragon 2 , 2 XL	60	740
Dragon 2B , 2B XL	45	560
Dragon 4 , 4 XL	72	885
Dragon 4B , 4B XL	57	700
Dragon 6 , 6 XL , 6 XXL	72	885
Dragon 8 , 8 XXL	45	560
Dragon 8B , 8B XXL	30	390
Dragon 9, 9XL	75	920



ZAWIESIA TERMOAKUMULACYJNE

JEDNA SZTUKA Z UCHWYTAMI





Wymiary sz/w/g [mm]	Ciężar [kg]	Cena netto [zł]
240 / 480 / 50	12	210
300 / 480 / 50	15	250



STEROWNIKI

DO WKŁADÓW POWIETRZNYCH

TRADYCYJNYCH LUB Z SYSTEMEM AKUMULACJI CIEPŁA

Model	Cena netto [zł]	
RT-08 OM	1 510	
RT-08 OM GRAFIK	1 610	
RT-08 OM GRAFIK WHITE / BLACK	1745	
Czujnik drzwiczek	215	









DUO INTEGRA

DO WKŁADÓW POWIETRZNYCH









TRADYCYJNYCH LUB Z SYSTEMEM AKUMULACJI CIEPŁA

Model	Cena netto [zł]	
RT-08 OM DUO INTEGRA	2 170	
RT-08 OM GRAFIK DUO INTEGRA	2 200	
RT-08 OM GRAFIK DUO INTEGRA WHITE / BLACK	2 300	
Czujnik drzwiczek	215	

DO WKŁADÓW Z WYMIENNIKIEM WODNYM

Model	Cena netto [zł]			
RT-08 G RT-08 G BUFOR	1 440			
RT-08 G WHITE / BLACK	1 570			
RT-08 G BUFOR WHITE / BLACK	1 570			
RT-08 GX BUFOR WHITE / BLACK (niezbędny czujnik drzwiczek)	1 890			
Czujnik drzwiczek (współpracuje tylko z RT-08 GX)	215			

DUO INTEGRA DO WKŁADÓW Z WYMIENNIKIEM WODNYM

Model	Cena netto [zł]			
RT-08 G DUO INTEGRA RT-08 G BUFOR DUO INTEGRA	1 800			
RT-08 G WHITE / BLACK DUO INTEGRA	1 850			
RT-08 G BUFOR WHITE / BLACK DUO INTEGRA	1 850			
RT-08 GX DUO INTEGRA RT-08 GX BUFOR DUO INTEGRA (niezbędny czujnik drzwiczek)	2 400			
RT-08 GX WHITE / BLACK DUO INTEGRA (niezbędny czujnik drzwiczek)	2 450			
RT-08 GX BUFOR WHITE / BLACK DUO INTEGRA (niezbędny czujnik drzwiczek)	2 450			
Czujnik drzwiczek (współpracuje tylko z RT-08 GX)	215			

UNICO FUSION – 5 MODUŁÓW / 3 ŚCIANY

Model	Ciężar [kg]	Wymiary sz/w/g [mm]	Cena netto [zł]	Dodatkowy moduł wysokość 330 mm cena netto [zł]
DRAGON WKŁADY POWIETRZNE				
Fusion D2/5, D2 Slim/5	219	950 / 1960 / 570	5890	1290
Fusion D2B/5, D2B Slim/5	210	950 / 1960 / 570	5890	1290
Fusion D4 Slim/5	233	950 / 1960 / 570	6260	1440
Fusion D4/5	250	950 / 1960 / 610	6420	1500
Fusion D4B Slim/5	220	950 / 1960 / 570	6260	1440
Fusion D6XL/5	231	950 / 1950 / 570	6260	1440
Fusion D8 Slim/5	192	740 / 2001 / 570	5250	910
Fusion D8/5	201	740 / 2001 / 610	5620	950
Fusion D8B/5	178	740 / 2001 / 570	5250	910
Fusion D8XXL/5	214	740 / 2180 / 610	5620	950
Fusion D8BXXL/5	186	740 / 2180 / 570	5520	910
DRAGON LIFT WKŁADY POWIETRZNE				
Fusion D2/5, D2 Slim/5 Lift	219	950 / 1960 / 610	6420	1440
Fusion D2B/5, D2B Slim/5 Lift	210	860 / 1960 / 610	6000	1290
Fusion D4 Slim/5 Lift	233	1100 / 1960 / 610	6420	1440
Fusion D4/5	250	1100 / 1960 / 770	6420	1440
Fusion D4B Slim/5 Lift	220	1100 / 1960 / 610	6420	1440
Fusion D6XL/5 Lift	248	1100 / 1950 / 610	6800	1570
Fusion D8B/5 Lift	190	740 / 2001 / 610	5890	1570
NEMO WKŁADY WODNE				
Fusion N2/5	238	950 / 1960 / 570	6640	1500
Fusion N2B/5	229	950 / 1960 / 570	6640	1500
Fusion N4/5	285	1100 / 1960 / 770	7170	1710
Fusion N4B Slim/5	273	1100 / 1960 / 570	7170	1710
Fusion N4B/5	273	1100 / 1960 / 770	7170	1710
Fusion N6XL/5	257	1100 / 1950 / 570	6910	1640
NEMO LIFT WKŁADY WODNE				
Fusion N2/5 Lift	238	1100 / 1960 / 770	6800	1500
Fusion N2B/5 Lift	229	950 / 1960 / 610	6800	1500
Fusion N4/5 Lift	285	1100 / 1960 / 770	7330	1710
Fusion N4B Slim/5 Lift	273	1100 / 1960 / 770	7330	1710
Fusion N4B/5 Lift	273	1100 / 1960 / 770	7330	1710
Fusion N6XL/5 Lift	257	1100 / 1950 / 610	7070	1640

UNICO FUSION CORNER – 5 MODUŁÓW / 2 ŚCIANY

Model	Ciężar [kg]	Wymiary sz / w / g [mm]	Cena netto [zł]	Dodatkowy moduł wysokość 330 [mm] cena netto [zł]
DRAGON WKŁADY POWIETRZNE				
Fusion C D2B/5, D2B Slim/5	149	860 / 1960 / 570	4550	910
Fusion C D4B Slim/5	160	950 / 1960 / 570	4980	1010
Fusion C D8B/5	116	740 / 2001 / 570	3910	600
Fusion C D8BXXL/5	119	740 / 2180 / 570	4180	600
DRAGON LIFT WKŁADY POWIETRZNE				
Fusion C D2B/5 Lift, D2B Slim/5 Lift	149	860 / 1960 / 610	4710	910
Fusion C D4B Slim/5 Lift	160	950 / 1960 / 610	5090	1010
Fusion C D8B/5 Lift	124	740 / 2001 / 610	4450	790
NEMO WKŁADY WODNE				
Fusion C N2B/5	164	950 / 1960 / 570	5250	1000
Fusion C N4B Slim/5	194	1100 / 1960 / 570	5250	1280
Fusion C N4B/5	194	1100 / 1960 / 770	5250	1280
NEMO LIFT WKŁADY WODNE				
Fusion C N2B/5 Lift	164	950 / 1960 / 610	5350	1050
Fusion C N4B Slim/5 Lift	194	1100 / 1960 / 770	5350	1280
Fusion C N4B/5 Lift	194	1100 / 1960 / 770	5350	1280

ELEMENTY ZABUDOWY FUSION

- Płyty betonowe
- Elementy łączące płyty i obudowę ze ścianą (bez kotw do ściany)
- Blenda ozdobna do drzwiczek wkładu
- Stalowa pokrywa
- Nóżki regulujące i poziomujące
- Cokół osłaniający nóżki

- Ceny nie zawierają izolacji na ścianę oraz przyłączy kominowych
- Możliwość rozbudowy do 7 modułów
- Przedstawione kolory są tylko poglądowe, mogą odbiegać od rzeczywistości
- Wysokości obudów ± 2 cm (wysokość zależy od regulacji nóżek)
- Wymiary poziome nie uwzględniają płyt akumulacyjnych (zawiesi). W przypadku ich zastosowania wymiar należy skonsultować.





www.unico-kominki.com

Unirol Sp. z o.o.
58-211 Uciechów, ul. Wrocławska 2a

tel. + 48 74 831 00 50
unico@unico-kominki.pl

Prezentowane dane mają charakter informacyjny. Producent zastrzega sobie prawo do zmian.